

ALAVO

DOLPHIN ALAVO

THE MODULAR BEHIND MIRROR WASHROOM SOLUTION

O & M MANUAL



CONTENTS

3	Alavo Thermostatic Mixing Valve
10	Alavo Water Service Valves and Filters
11	Alavo Hand Dryer Unit
16	Alavo Soap Dispenser System
22	Cleaning the Compressor (Foam Dispensers)
23	Clean the Soap Tank
24	Alavo Tap Unit
28	Alavo Lighting Colour Control
29	Alavo Light Sensor Control
30	Alavo Light Sensor Board Inspection / Replacement / Temporary Repair / Over-Ride
31	Alavo Cleaner's Switch & Refill Indicator Light
32	Alavo Fuse Checking / Resetting
33	Alavo Control Screen Setting
34	Alavo Mirrors
36	Alavo Gas Struts
38	Alavo Commissioning Checklist

ALAVO THERMOSTATIC MIXING VALVE

TECHNICAL DATA

Operating Range	High Pressure	Low Pressure
Maximum static pressure - bar	10	10
Hot & cold flow pressure - bar	1.0 to 5	0.2 to 1
Hot supply temperature - °C	52 to 65	52 to 65
Cold supply temperature - °C	5 to 20	5 to 20

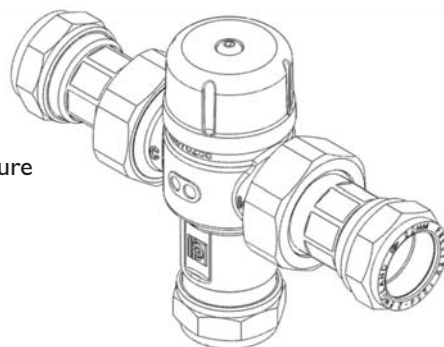

Minimum hot inlet to mixed outlet temperature differential = 10°C Note: Valves operating outside these conditions can not be guaranteed by the Scheme to operate as Type 3 valves.

The highest flow rates will be achieved under balanced pressure conditions, but the pressure at the valve inlets must be within a ratio of 5:1 under flow conditions and the size and layout of pipework and fittings must take this into account.

IMPORTANT NOTE

Flush supply lines thoroughly before connecting Dolphin Alavo unit. Do not allow dirt, teflon tape or grease to enter TMV.

CONNECTION

Before connection, the system operating conditions of inlet pressures, hot water temperature and hot and cold water flow rates should be determined and confirmed to be within the expected conditions of normal use.

Valves must operate in either a high pressure setting or a low pressure setting valves are not capable of operation with, for instance hot water supply in one pressure range and cold water supply in the other pressure range. In these conditions it is necessary to either boost one pressure or reduce the other so that both supplies are within a common pressure range.

Correct location of the mixing valve is important to ensure that it is accessible for commissioning and servicing.

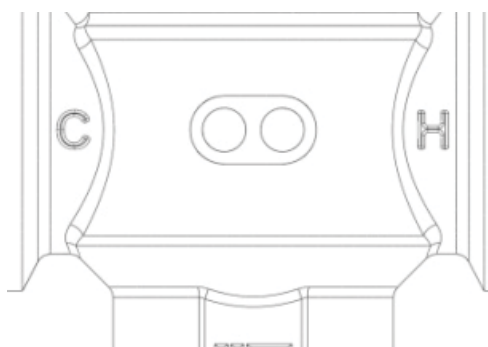

ALAVO THERMOSTATIC MIXING VALVE

APPLICATION

The Dolphin Alavo TMV3 thermostatic mixing valve has been independently tested by WRc-NSF against the requirements of BS 7942:2000 and NHS D08 and certified as complying with the requirements of the TMV3 Scheme and is suitable for use in the designations shown in the table below.

Valves approved for designation for use 'HP' only:

If a water supply is fed by gravity then the supply pressure should be verified to ensure the conditions of use are appropriate for the valve.

The range of available temperature adjustment is 35°C to 48°C **BUT** the mixed water temperature at the terminal fitting should never be set to a temperature that exceeds the maximum set outlet temperature for the application.

COMMISSIONING

The valve must be commissioned under normal site system conditions and after establishing supply conditions with the hot and cold water supplies open, leave the system running to allow temperatures and pressures to stabilise and be checked.

Prior to commencing commissioning, the following checks should be carried out.

- The designation of the thermostatic mixing valve matches the application.
- The supply pressures and temperatures are within the operating range of the valve.
- Isolating valves and strainers are provided.
- The supply temperatures are within the range permitted for the valve and by guidance information on the prevention of legionella etc

If all these conditions are met, proceed to set the temperature as described below.

The PeglerYorkshire model P405 thermostatic mixing valve is supplied factory set at 43°C but the valve may be simply adjusted after installation.

The mixed water temperature at the terminal fitting must never exceed the maximum temperature setting for the particular application (See Table 2). Note, It is not possible to install one thermostatic mixing valve to supply two differing applications unless the temperature of the higher setting is limited to that of the lower application.

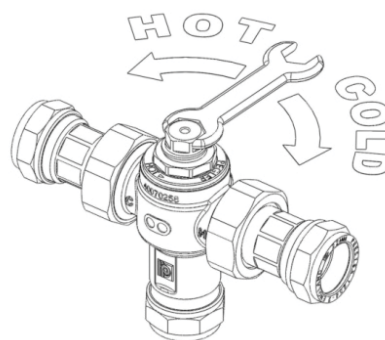

ALAVO THERMOSTATIC MIXING VALVE

- Remove the plastic cap on top of the valve with the supplied Allen key or other suitable tool.
- Using a close fitting spanner, reduce the mixed outlet temperature by turning clockwise.
- Increase the mixed water outlet temperature by turning counter clockwise.

When the valve has been installed with the correct conditions of use it is advised that the valve is subjected to exercise prior to the commissioning at the application temperature. With hot and cold water flowing through the valve, operate the valve from full cold to full hot at least three times.

With the valve at the full cold position bring the valve to the correct application temperature by turning the spanner counter clockwise. If the valve overshoots this temperature, return the valve to the full cold condition, and reset it to the correct temperature $\pm 0.2^{\circ}\text{C}$. Do not set a valve on a lowered temperature as this will not provide consistent operation.

When the valve is set to the required temperature for the application carry out 5 cold water isolation tests to further exercise the valve.

COMMISSIONING TEXT SEQUENCE

After adjust the temperature of the mixed water in accordance with the valve application (see Table 2) and the carry out the following sequence:

1. Record the temperature of the hot and cold water supplies.
2. Record the temperature of the mixed water at the largest draw-off flow rate.
3. Record the temperature of the mixed water flow at a smaller draw-off flow rate, which shall be measured.
4. Isolate the cold supply to the mixing valve and monitor the mixed water temperature recording the maximum temperature achieved and the final stabilised temperature.
5. Record the equipment, thermometer etc. used for the measurements.

NOTE

The final stabilised temperature should not exceed the values in Table 3.

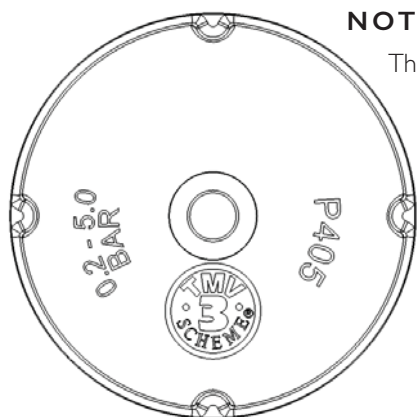

After correct commissioning secure the protective blue TMV 3 cap using the supplied screw ensuring that the blue colour TMV 3 cap is fitted, this will indicate the valve has been commissioned to the TMV 3 standard.

ALAVO THERMOSTATIC MIXING VALVE

IN-SERVICE TESTING

The purpose of in-service testing is to regularly monitor and record the performance of the thermostatic mixing valve. Deterioration in performance can indicate the need for service work on the valve and/or water supplies.

Carry out the test sequence detailed below using the same or equivalent equipment as used for commissioning the valve.

- Check the designation of the thermostatic valve matches the application.
- Check that the supply pressures and temperatures are within the operating range of the valve.
- Check that the supply temperatures are within the range permitted for the valve and by guidance information on the prevention of legionella etc
- Check there have been no significant changes in inlet supply temperatures and pressures since commissioning or the previous in service test.

If significant changes have occurred it is recommended to re-commission the valve.

If the mixed water temperature has changed significantly from the previous test results (e.g.>1°C), record the change and before re-adjusting the mixed water temperature carry out the following checks;

- All in-line or integral strainers are clean
- Any in-line or integral non-return valves or other anti-backsiphonage devices are in good working order.
- Any isolation valves are fully open.

With an acceptable mixed water temperature complete the Commissioning test sequence detailed above. If the final mixed water temperature is greater than the values in Table 3 and/or the maximum temperature exceeds the corresponding value from the previous test results by more than about 2°C the need for service work is indicated (see TMV servicing and cleaning instructions).

In-service tests should be carried out with a frequency which identifies a need for service work before an unsafe water temperature can result.

ALAVO THERMOSTATIC MIXING VALVE

FREQUENCY OF IN-SERVICE TESTING

6 to 8 weeks after commissioning carry out the test sequence detailed above.

12 to 15 weeks after commissioning carry out the test sequence detailed above.

Depending on the results obtained, the following course of actions must be followed:

- If no significant changes (e.g. <1 °C) in mixed water temperature are recorded between commissioning and testing at 6 to 8 weeks, or between commissioning and testing at 12 to 15 weeks, the next in-service test can be deferred to 24 to 28 weeks after commissioning.
- If small changes (e.g. 1 to 2 °C) in mixed water temperature are recorded in only one of these periods, necessitating adjustment of the mixed water temperature, then the next in-service test can be deferred to 24 to 28 weeks after commissioning.
- If small changes (e.g. 1 to 2 °C) in mixed water temperature are recorded in both of these periods, necessitating adjustment of the mixed water temperature, then the next in-service test should be carried out at 18 to 21 weeks after commissioning.
- If significant changes (e.g. >2 °C) in mixed water temperature are recorded in both of these periods, necessitating service work, then the next in-service test should be carried out at 18 to 21 weeks after commissioning.

The general principle to be observed after the first 2 or 3 in-service test is that the intervals of future tests should be set to those which previous tests have shown can be achieved with no more than a small change in mixed water temperature.

It is recommended that In-Service Tests are carried out once every 6 months as a minimum.

- a. Checking/adjusting/balancing the TMV3
 - Recommended Code of Practice for Safe Water Temperatures (2).pdf

NOTE

If there is a residual flow during the commissioning or in service test during the cold water supply isolation test then this is acceptable providing the temperature of the water seeping from the valve is no more than 2°C above the designated maximum mixed water outlet temperature setting of the valve as defined in Table 2.

Temperature readings should be taken at the normal flow rate after allowing the system to stabilise. The sensing part of the thermometer probe must be fully submerged in the water that is to be tested.

Any TMV that has been adjusted or serviced must be re-commissioned and re-tested in accordance with the manufacturer's instructions.

ALAVO THERMOSTATIC MIXING VALVE

CLEANING AND SERVICING

Most domestic water supplies contain calcium which will separate out when the water is heated in a system. The degree and speed of scaling may vary depending on factors such as water flow rates, system design, the hardness of the water and the temperature to which the water is heated. Deposits of scale may over time form in the valve, particularly at the hot inlet. The formation of the scale may adversely affect the performance of the valve which will be detected during the in-service testing.

If this occurs it will be necessary to remove the valve for de-scaling and servicing.

- Isolate the hot and cold supply.
- Remove the valve to a clean working area.
- Remove the protective cap.
- Unscrew the headwork of the valve.
- Carefully remove the element and valve assembly and put to one side.
- Remove the main spring and flow guide and carefully put to one side.
- Inspect the components for contamination or damage.
- Clean or replace as necessary
- Remove the two o rings
- Clean the valve body and headwork using a propriety de-scaler
- Thoroughly rinse the body and headwork in clean water.
- Carefully fit new o rings from the service kit taking care to ensure they are not damaged and are correctly located.
- Lubricate the o rings with the lubricant provided.
- Re-fit the flow guide and spring lubricating the flow guide around the greatest diameter with the lubricant provided
- Lubricate the shuttle valve with the lubricant provided
- Re-fit the shuttle valve and element assembly.
- Re-fit the headwork ensuring correct tightening
- Re-fit the valve assembly
- If after cleaning the valve, and replacing the o ring seals, the valve does not function correctly, it may be necessary to replace the thermal element.

ALAVO THERMOSTATIC MIXING VALVE

SPARES

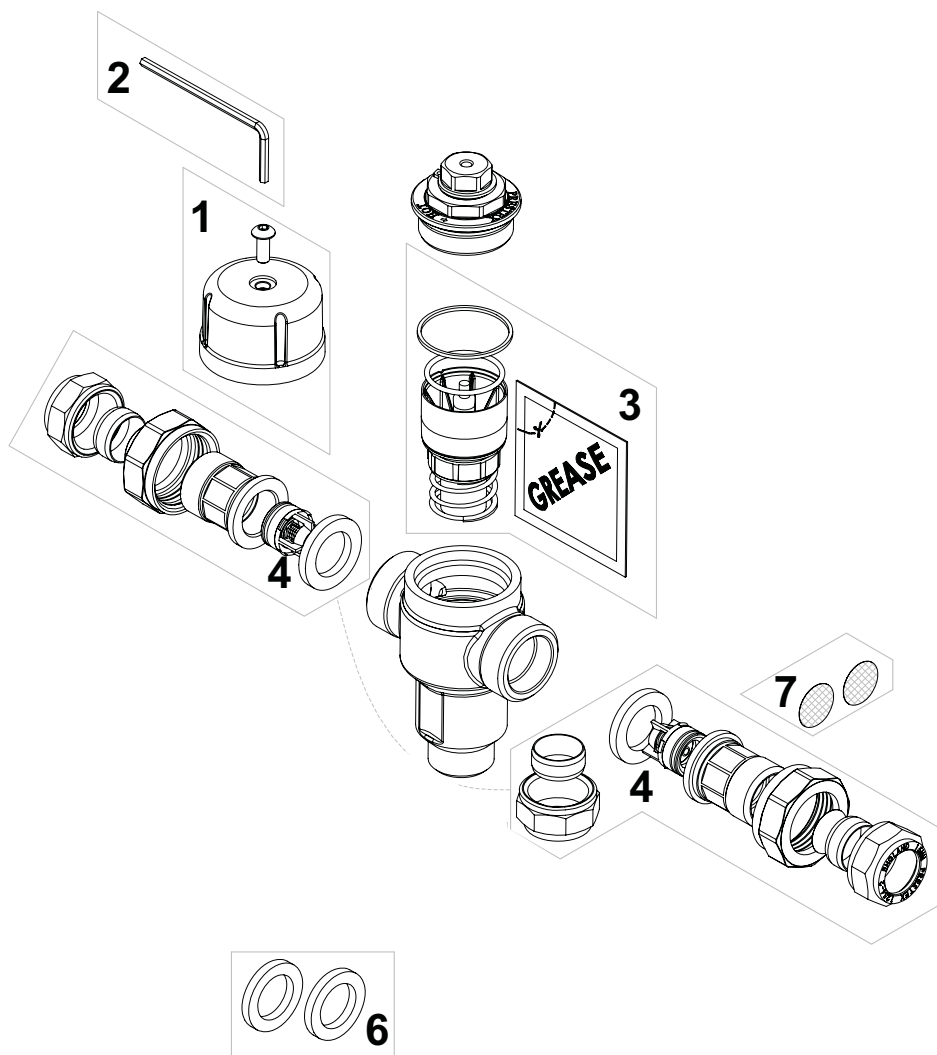

Spare part order code

- A-1 854550
- A-2 854551
- B 854447
- C 854454
- D 854449 (15mm), 854450 (22mm)
- F 854456 (15mm), 854457 (22mm)
- G 854455 (15mm), 817012 (22mm)

Description

- Blue TMV 3 Protective cap complete with screw
- White TMV 2 Protective cap complete with screw
- Hexagon key
- Service kit
- Tailpiece Strainer kit
- Sealing washer
- Wafer Strainer

ALAVO WATER SERVICE VALVES AND FILTERS

DEFINITION

Dolphin Alavo incorporates water service valves at the water inlets. They combine the following functions:

- A quarter turn isolation ball valve WRc certified for reliability with slotted or handle operation.
- Strainer/filter that is easy to check/remove via the port as below. It strains/filters all water to the Dolphin Alavo system simplifying the O&M process.
- A port giving side access to the strainer/filter and ball valve while the system is under pressure, without draining down or breaking the pipework.

Regular checks of the strainer/filter are recommended. To check/ remove/replace/clean the strainer/filter simply shut the ball valve, remove the screw cover plate and access the strainer/filter. Obviously reverse the process to re-open the valve

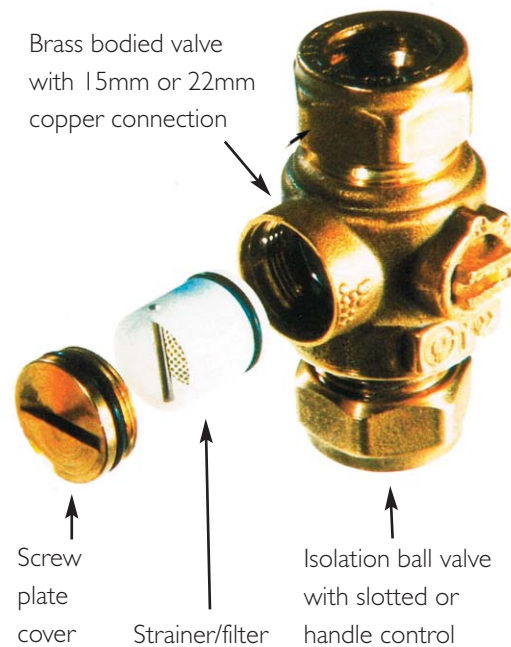

ALAVO HAND DRYER UNIT



TECHNICAL DATA

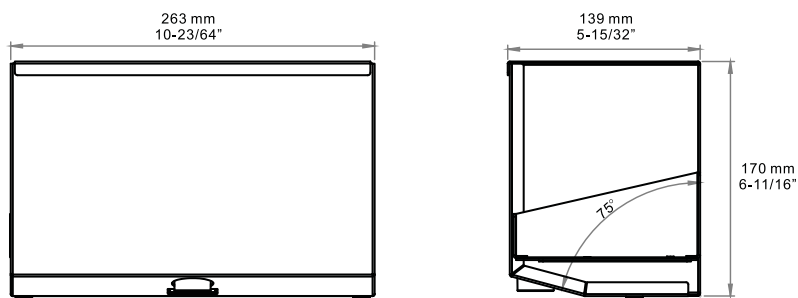

Item category

Operating voltage

Air output temperature

Air volume

Motor type

Motor thermal protection

Heater element

Heater thermal protection

Drying time

Stand by power

Circuit operation

Ssensor range

Timing protection

Performance

220-240 Vac, 50/60 Hz, 0.84-1.0kW

55°C (131°F) - ambient tem 25°C (77°F)

101.7m³/h, (59.8 CFM)

11/16HP, 500w, 29,000 rpm, brush type, dual ball bearings

Auto resetting thermostat turns unit off at 105°C (221°F)

500w

Thermal cut off at 139°C (282°F)

Less than 15 seconds

Less than 0.5w

Infrared automatic, self adjusting

2" to 10" (51mm to 254mm) auto adjust 7" (18cm± 2cm)

60 seconds auto shut off

For more detailed instructions on this hand dryer including sensor, heater and airspeed adjustments and instructions on how to change parts go to BC2003BM on our website or click here <https://www.dolphinsolutions.co.uk/product/behind-mirror-hand-dryer/>

ALAVO HAND DRYER UNIT

CLEANING AND MAINTENANCE

Periodic cleaning of the unit is recommended to ensure optimum performance.

- Isolate the electrical supply.
- Remove the two cover-mounting screws. Remove the cover.
- Clean all dust lint from the interior of the dryer. Wipe the cover with a damp cloth and mild cleaning solution. Do not Soak. Never use abrasives to clean the cover.
- Replace the cover. Do not over tighten the screws.

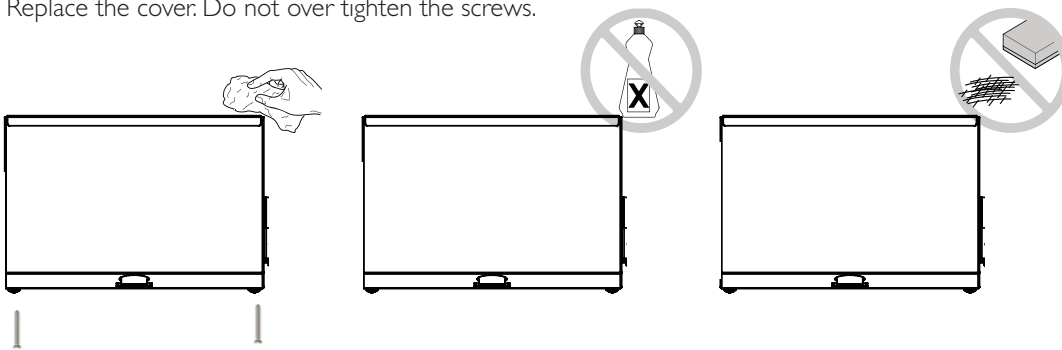

PARTS LIST

Key	Description	Quantity
01	Enclosure (casing)	1
02	Security Hex screw	2
03	Blower housing (upper)	1
04	Blower housing (below)	1
05	Motor 240vac@500w	1
06	Motor rubber (upper)	1
07	Mottor rubber (below)	1
08	Heater assembly 240vac@500w	1
09	Circuit board module (CMB), 220-240vac	1
10	Base plate	1
11	Nylon hole bushing	1
12	Insulation Mylar	1
13	Terminal block	1
14	Blower mounting bracket	1
15	Sensor bracket	1
16	Sensor	1
	Sensor (blue)	1
17	Cable clamp	1
18	Cable protector	1
19	Grounding screw	1
20	Left box bracket	1
21	Right box bracket	1
22	Box	1

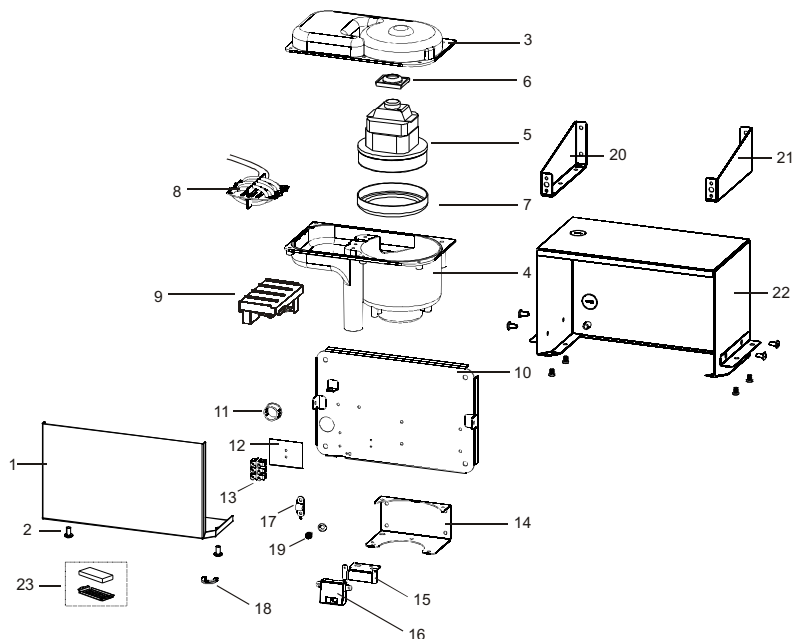

ALAVO HAND DRYER UNIT

REMOVING AND REFITTING A HAND DRYER

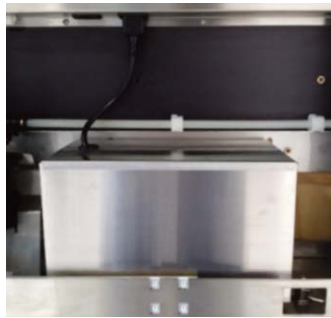

The hand dryer in situ



1. Slide open the fuse holder



2. Remove the plug complete



3. Undo the 1st T30V retaining screw



4. Undo the 2nd T30V retaining screw



5. Lift out the dryer unit



The dryer unit with the cover on



The dryer unit with the cover off



6. Replace the fuse in the holder

To refit a dryer follow steps 1 to 5 above in reverse order.

ALAVO HAND DRYER UNIT

TROUBLESHOOTING – DIAGNOSTICS AND REMEDIES

CORRECTIVE ACTIONS FOR INITIAL INSTALLATION FAILURES

Q If the dryer will not run

A First ensure that the breaker supplying the dryer is operational. If it is, disconnect the power and remove the dryer cover. Taking suitable precautions to avoid shock hazard, reconnect the power and check for voltage at the terminal block. Verify that connections are made correctly.

Q The dryer cycles by itself or runs constantly

A Ensure that there is no obstacle on or in front of the infra red sensor. Clean any dirt or debris off the sensor lens. If problems persist replace sensor.

Q The dryer makes a loud noise and does not run for a complete cycle

A Ensure that the supply voltage is correct. Dryer will make a loud humming noise if the input voltage is too high. Verify voltage requirement on unit rating label and correct supply as required. If CBM has been damaged, replace CBM, infra red sensor module and VR component and cable.

Q The dryer runs but air stream is low pressure and or low velocity

A Ensure that the supply voltage is correct. Dryer will run weakly if the input voltage is too low. Verify voltage requirement on unit rating label and correct supply as required.

CORRECTIVE ACTIONS FOR IN-SERVICE FAILURES

Q If the dryer will not run

A First ensure that the breaker supplying the dryer is operational. If it is, disconnect the power and remove the dryer cover. Replace the CBM and infra red sensor module. Taking suitable precautions to avoid shock hazard, reconnect the power and check for voltage at the terminal block.

Q The infra red sensor only 'sees' close range objects

A Ensure that there is no obstacle on or in front of the infra red sensor. Clean any dirt or debris off the sensor lens. If problem persists, disconnect the power and remove the dryer cover. Taking suitable precautions to avoid shock hazard, reconnect the power and try carefully adjusting the sensitivity control (yellow shaft in blue box on CBM) to increase the sensing range. If problem persists replace sensor.

Q The heater gets hot but no air stream is produced

A Disconnect the power. Remove the dryer cover and disassemble the blower motor/fan housing. Replace the fan motor.

Q The dryer only blows cold air during a full cycle

A Disconnect the power. Remove the dryer cover and disassemble the blower motor/fan housing. Test the thermostat for open circuit. Check the heater element for signs of burning or breakage. Damaged element must be replaced.

Q The air stream is low pressure and velocity

A Check the output nozzle for obstructions. If none are present, disconnect the power. Remove the dryer cover. Remove any dust/lint build up from intake vent slots. Disassemble the blower motor/fan housing. Check the motor brushes for worn condition ($\leq 1-3/16"$ [30mm] graphite remains) and replace them if necessary

TAP

Q If the tap will not work?

A Firstly, ensure the water supply is on and that all shutoff valves are on, so that the valve position is parallel to the pipe. This includes the valves in the hot loop. If it is, then check the tap is connected to the power supply and make sure all connections are pushed tightly together.

Q The tap is dripping?

A This is normally due to the solenoid which is a serviceable part, (see section "Alavo Tap Unit" of the O & M manual). Or it could be either the spring, or there could be something keeping the diaphragm open. If it is still dripping, please contact us and ask for a replacement solenoid.

Q The water flow is poor?

A This could be due to the water pressure in the building, 1 to 3 bar is recommended. If the water pressure is normal, check the solenoid has not been done up too tightly. Or check to make sure the aerator is clean, (see section "Alavo Tap Unit" of the O & M manual).

Q Tap self-activating?

A The tap will self-activate if the sensor is too close to the sink, this is because it picks up a reflection off the surface. You can tilt the sensor slightly so it does not self-activate. The recommended height from the sensor to the sink is 300mm.

SOAP DISPENSER

Q No soap?

A Firstly, check the power supply is connected, if so, then check the soap dispenser is plugged in. You can check to see if it has power by pressing the grey button on the soap dispenser.

Q You can hear the soap pump but no soap comes out, or it is coming out too thick?

A Check that there is actually soap connected to the pump, if so, make sure it is Dolphin Foaming Soap, any other soap will not work correctly. If it is too thick, clean the compressor. (See section "Cleaning the compressor" of the O & M manual). If the soap is wrong, drain it out, (see 'clean the soap tank' of the O & M manual).

ALAVO SOAP DISPENSER SYSTEM

SOAP TYPE

It is **critical** to the functioning of the soap system on Alavo units that the correct soap is used. The wrong type invalidates the warranty.

The correct soap is a foaming type with **water thin consistency**.

‘Conventional’ thicker pearlescent soaps (for example, ‘washing up’ liquid consistency) will block the system. We can send a sample if you are unsure. Rather, call and check with us than use the wrong soap.

SOAP TANK SYSTEM 2012 – 2017 (MULTI-MODULE VERSION) FILL / REFILL AND BLEED THE SOAP SYSTEM



1. Use water thin foaming soap only



2. Remove lid from tank and fill

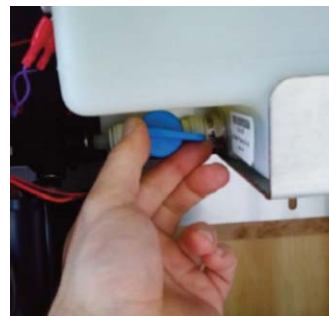

3. Ensure valve on tank is open



4. Ensure the bleed valve is open at the far left hand end of the units to ensure soap flows through, check for leaks and close valves if any are present



5. Locate the grey override button on each soap dispenser pump housing



6. Depress the grey override button and hold until soap begins to flow

ALAVO SOAP DISPENSER SYSTEM

SOAP TANK STAND ALONE SYSTEM 2012 – PRESENT FILL / REFILL AND BLEED THE SOAP SYSTEM

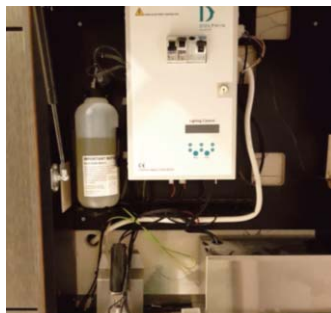

1. Locate the soap tank adjacent to the control box



2. The soap tank with grey override button on pump housing indicated



3. Unscrew the soap tank from the pump housing and lower out, refill and replace.



4. Prime pump by locating and depressing the grey button on the pump housing as indicated here until soap flows

ALAVO SOAP DISPENSER SYSTEM

SOAP REFILL CARTRIDGE SYSTEM 2018 – PRESENT REFILL THE SOAP CARTRIDGE SYSTEM

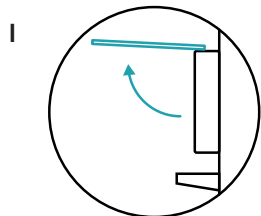

Open mirrors on front of Alavo

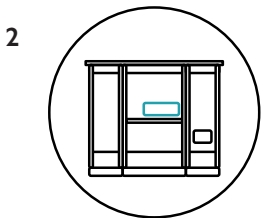

Locate the white cardboard soap refill box

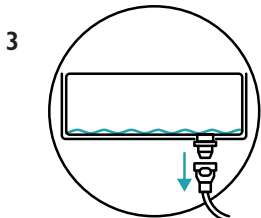

Disconnect empty soap refill box by pressing firmly on the button and pulling downwards

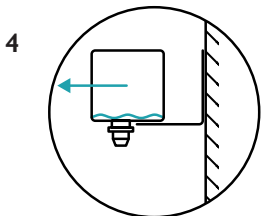

Slide empty soap refill box off bracket. Please recycle cardboard box and ramp

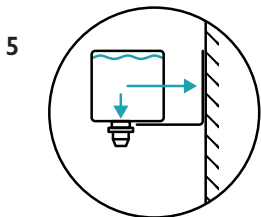

Pull out spout from inside new soap refill box and slide into bracket

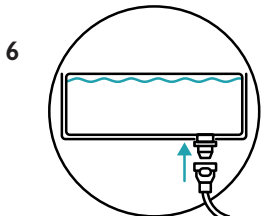

Push connector firmly onto refill spout

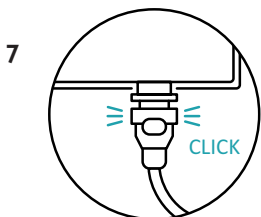

Click indicates successful connection

To bleed the soap system, attach pouch (Cartridge) and let it drain through into reservoir. Then follow steps 4 – 6 on 'Soap Tank System 2012 – 2017' (The first time this is done the reservoir will be filling from empty and will use most of the cartridge in one go. It is recommended that after the reservoir is full to attached a new full refill cartridge.

Foaming soap refill cartridges can be ordered online or via the phone 01424 202224

ALAVO SOAP DISPENSER SYSTEM

REMOVING AND REFITTING A SOAP DISPENSER – 12v & 6v VERSIONS THE 12v VERSION SOAP DISPENSER



The 12v soap dispenser in-situ



1. Turn off the soap supply at the tank / reservoir



2. And the same at the opposite end



3. Open the pipe clips at the tee



4. Release the tee



5. Undo the 2 x T20V retaining screws



6. Remove the conduit cover

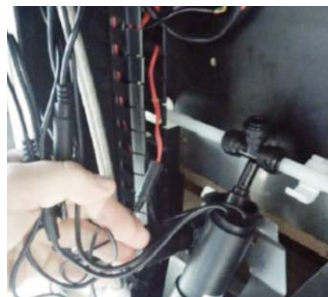

7. Remove all the dispenser wiring

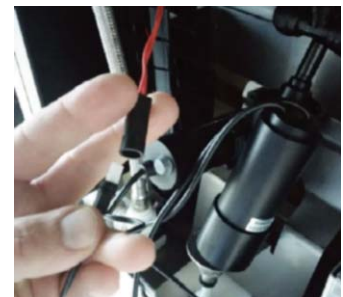

8. Unplug the soap dispenser



The soap dispenser plug



9. Remove the dispenser



The 12v soap dispenser

To refit a 12v soap dispenser follow steps 1 to 9 above in reverse order

ALAVO SOAP DISPENSER SYSTEM

THE 6v VERSION SOAP DISPENSER – GEARBOX ONLY

Remove the soap pump as per steps 1 to 4 above at the start of this section on page 18.



5. Push the pump up out of the way

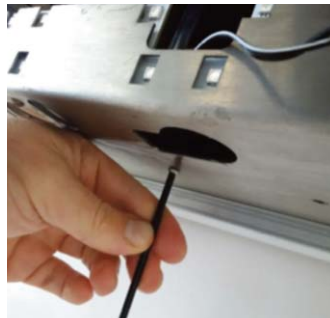

6. Undo the 2 x T20V retaining screws

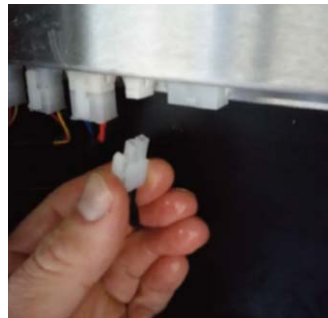

7. Unplug the gearbox from trunking...

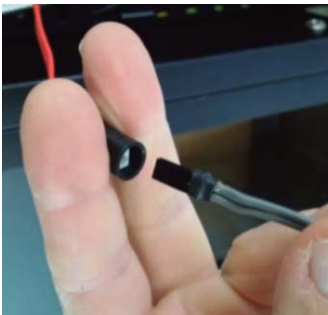

7. Or from the cable (later design)



8. Lift out the gearbox

To refit a 6v gearbox follow steps 5 to 8 above in reverse order.

Finally in all cases to complete the soap dispenser refit:



Close the pipe clips



Refit the cover to the conduit

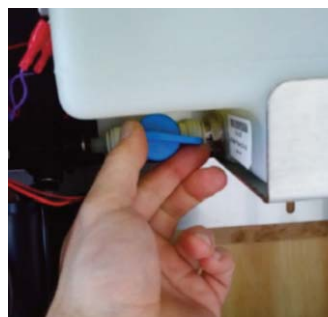

Turn the soap valves back on

NOTE

If no soap dispensers or taps work in a whole run check that the cleaner's switch is not mistakenly left on – for detail on what the cleaner's switch is and how to operate see instruction for operating cleaner's switch later in this manual. Page 31.

ALAVO SOAP DISPENSER SYSTEM

THE 6v VERSION SOAP DISPENSER – PUMP ONLY

Turn off soap valves at the tank/reservoir and at the vent pipe.



3. Undo cable tie restraining pump



4. Remove pump from gearbox



5. Disconnect pump from tee



6. Turn tee up to retain soap



7. Push new pump firmly into tee



8. Fit new pump into gearbox

To complete the refit of a soap pump follow steps 3 & 4 above in reverse order

CLEANING THE COMPRESSOR (FOAM DISPENSERS)

Dolphin foam soap dispensers include mesh filter inside the compressor which should be regularly cleaned with warm water. It is recommended to clean the mesh tubing every six (6) months, at a minimum, and after periods of non-use, to avoid decrease in soap volume due to clogging by soap and debris. The mesh tubing should be rinsed with warm water and reassembled on the compressor. The following steps show you how it is done



1. First undo the grub screw which hold the sensor in place



2. Then remove the clear tube from the compressor



3. Then with a spanner undo the nut

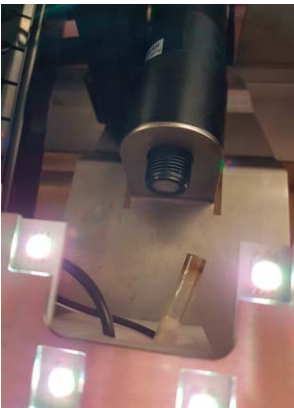

4. Then remove the mesh filter from the bottom of the compressor



5. Push the white filter out of the black surround

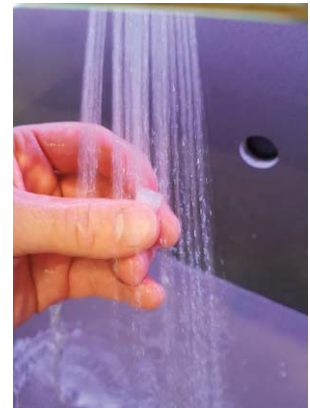

6. Clean with warm water, and then reassemble

CLEAN THE SOAP TANK

Clean out the tank ever month by flushing warm water through the hoses and pump until clean water is released from the spout. (Not needed if you have the 2018 – present Soap Pouch System)

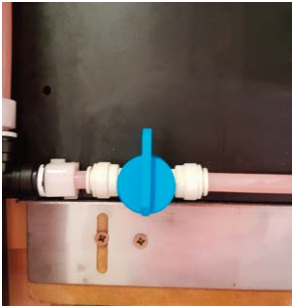

1. First turn the shut off valve perpendicular to the pipe

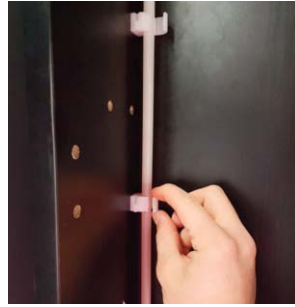

2. Then release the pipe clips which hold the vent pipe

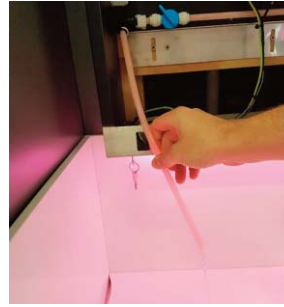

3. Pull the pipe out of the clips and direct it into the sink.

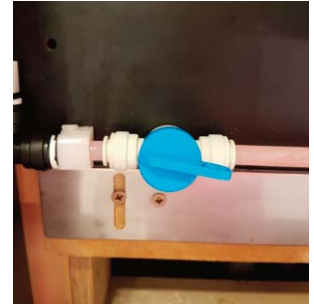

4. Then turn the shut off valve horizontal to the pipe which will allow the soap to flow out.

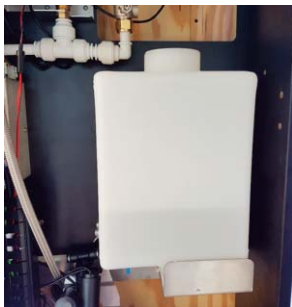

5. Then fill the soap tank up with water and flush it through the pipes

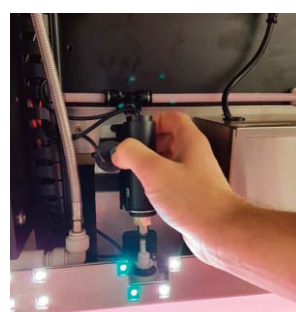
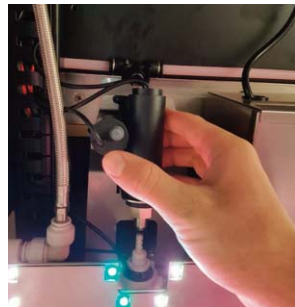

6. Whilst the water is flushing through locate the grey primer button on the soap dispenser and hold it down for a minute. (repeat for all soap dispensers)

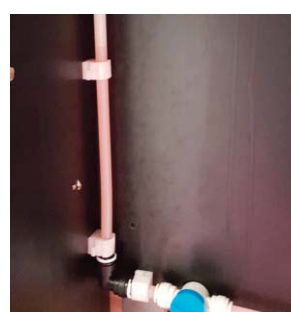

7. Once these steps have been completed put the vent pipe back and fill the soap tank up with Dolphin foaming soap (insure the shut off valve is in a horizontal position)

ALAVO TAP UNIT

ADJUSTING THE WATERSPRAY ANGLE



Tap unit seen from beneath with flap open



Tap unit seen from above with flap open



To adjust angle of water spray, simply:

1. Loosen both screws with TX 20 screwdriver as shown in Fig 1.
2. Adjust up or down until desired angle is reached.
3. Tighten screws.

ALAVO TAP UNIT

CHANGING THE AERATOR



1. Locate the aerator



2. Use a 22mm spanner to undo the colour (anti-clockwise to undo)



3. Remove finally with your hands



4. A new aerator and housing



5. Fit the new aerator: MAKE SURE the rubber washer is in place between the aerator and the tap body.



6. Tighten with a ½ turn – DON'T overtighten as the housing material is acetal plastic and easily stripped.

ALAVO TAP UNIT

REMOVE A TAP SOLENOID AND CLEAN



1. Isolate the water supply locally



2. Unplug the solenoid



3. Unscrew the solenoid from body



Solenoid clear of body



4. Check diaphragm for particles



5. Clean with water or replace

Refit solenoid as steps 1 to 3 above in reverse order

ALAVO TAP UNIT

CHECK / REALIGN SOLENOID INTERNAL PARTS (IF TAP DRIPPING/CONTINUOUSLY RUNNING AFTER CLEAN)

Remove tap solenoid as steps 1 to 3 on page 26



4. Remove diaphragm from solenoid



Spring fallen onto its side



5. Remove pin and check spring



6. Remove the spring from



7. Catch 2 coils & stretch spring slightly



8. Replace spring in pin solenoid **holding up**



9. Refit diaphragm



Solenoid

Complete Refit solenoid as steps 1 to 3 on page 25 in reverse order

ALAVO LIGHTING COLOUR CONTROL

ADJUSTING THE PERIMETER (HALO / SIDE) AND ICON LIGHTING COLOUR



1. Open the left hand mirror to access the control box



2. The control box



3. Press Menu on the Lighting Control



4. Press enter on the Lighting Control – thereafter follow the screen prompts, 'Enter' allows you to adjust the lighting colour in that section (using + and – accordingly), 'Menu' takes you to the next section of the Lighting Control

ALAVO SCREW DETAIL

SECURITY SCREW USED IN BOTTOM PLATE OF ALAVO TO SECURE FITTINGS



AT20V/T30V pin torx security screw

ALAVO LIGHT SENSOR CONTROL

ADJUSTING LIGHT SENSOR CONTROL



1. Locate cleaner's switch and fit key



2. Twist key clockwise to turn on



3. Locate the control box and isolate the power



3. Open control box with the key



4. Control box open showing main PCB



5. Locate blue sensor control on PCB

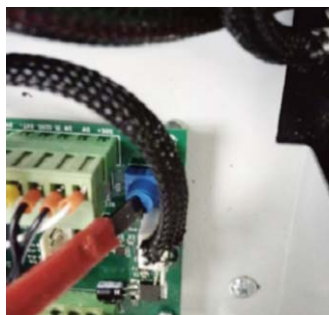

6. Use slotted screwdriver to adjust

Close control box, turn power and cleaner's switch back on and test. Redo steps 1 to 6 if required.

If adjusting the sensor control does not make any improvement it may be that the light sensor board is broken, see page 27 for instructions to check.

ALAVO LIGHT SENSOR BOARD INSPECTION / REPLACEMENT / TEMPORARY REPAIR / OVER-RIDE

A broken light sensor board will typically result in the lighting working for a few moments after being powered on before it then shuts down.

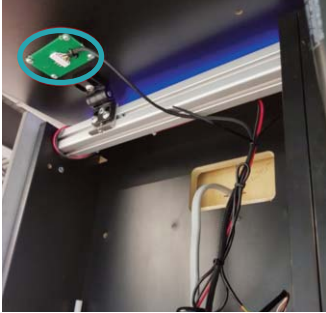

1. Light Sensor board circled. This is always on the left hand side of a multi-unit run with the control box, screwed to the underside of the mirror flap with the photocell locating in the circular cut-out. It is plugged into the top of the control board.



2. Removing the screws will allow the sensor board to be removed for inspection. The photocell (circled) can be damaged prior to installation; either or both of the pins that attach to the board may be broken.

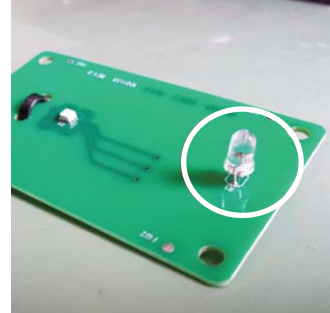

3. The very occasional problem that can occur is the metal connector pins within the plastic connector housing are not fully pushed in. This will show up by the pins not being a uniform depth at the open end of the plastic connector housing. This can apply equally to either of the corresponding connector housings.

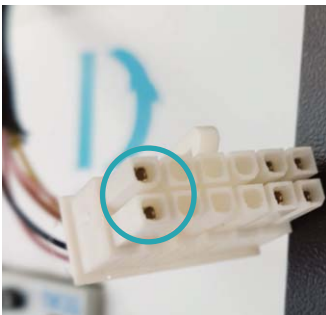

4. If the connectors are OK but the photocell is damaged the photocell can be bypassed to get the lights working while awaiting a replacement light sensor board.

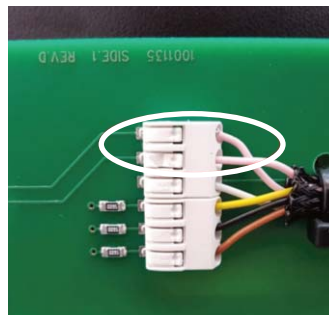

5. The two pink wires can be removed from the light board by depressing the circled terminal connectors with a thumb nails or small screwdriver to release the wires. The exposed wire strands can then be twisted together to make a connection, and if desired, reinserted into one of the terminals.

ALAVO CLEANER'S SWITCH

OPERATING CLEANER'S SWITCH (WHICH DISABLES TAP AND SOAP OPERATION WHEN ON)



1. Locate cleaner's switch and fit key



2. Turn key clockwise to turn switch on / anticlockwise to turn switch off.

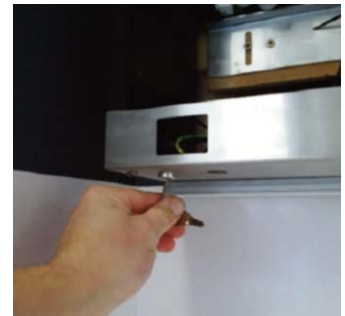

NOTE The key will not pull out from the switch while the switch is in the on position.

ALAVO REFILL INDICATOR LIGHT

LIGHT KEY

The refill indicator light serves more than one function:

Blue solid – low soap

Green solid – low paper towels (if fitted)

Red solid – service key switch activated

Red flashing – electrical circuit broken (e.g. fuse blown)

More than one indication will give a colour mix, for example:

Red & Blue = Purple

Blue & Green = Cyan

ALAVO FUSE CHECKING / RESETTING

CHECKING/RESETTING THE FUSES (CURRENT MODEL)



1. Locate the control box and isolate the power



2. Open the control box with the key



3. Locate the PCB on the reverse of the door

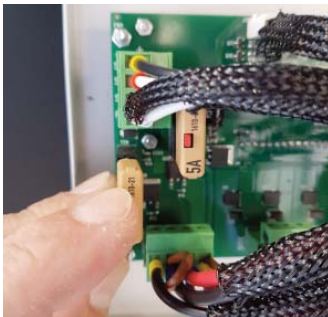

4. Locate and check/reset the fuses

If any of the low voltage elements (everything except the hand dryers) are not working it may be necessary to check and reset/replace the fuses.

CHECKING / REPLACING THE FUSES (PREVIOUS VERSION)



1. Isolate the power at the RCD as step 1 above. Then open the control box to expose the main controller PCB at the back of the control box.



2. Locate the fuses at the bottom of the main controller PCB.

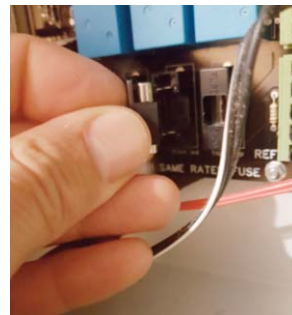

3. Remove the fuses one by one by pulling at the back cover – no tools required



4. Check each fuse – if a fuse has blown the wire will have broken within the glass.

To replace fuses simply follow steps above in reverse order.

If fuses continue to break then call our service team to help with identifying the cause.

ALAVO CONTROL SCREEN SETTING

ADJUSTING THE CONTROL SCREEN CONTRAST (CURRENT MODEL)



1. Locate the control box and isolate the power



2. Open the control box with the key



3. Locate the PCB on the reverse of the door



4. Locate and check/reset the fuses



5. Locate the Blue potentiometer

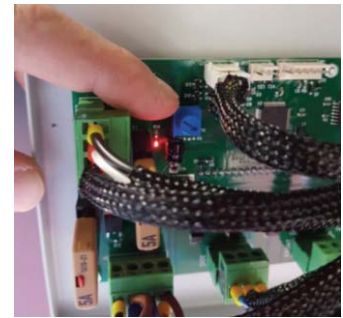

6. Adjust the potentiometer to suit

ALAVO MIRRORS

IMPORTANT NOTES

As standard, Dolphin Alavo mirrors are Mirox MNGE as manufactured by AGC Glass Europe – see www.yourglass.com for more technical data.

IMPORTANT NOTES

- The Dolphin Alavo Mirrors are coated with glass products for use in interior applications only.
- For safety applications, the Dolphin Alavo mirror has a safety backing film applied to the painted side of the glass
- The Dolphin Alavo mirror can be used in damp environments (kitchens, bathrooms etc) but should never be immersed in water.
- The use of safety gloves and appropriate personal protection is strongly recommended during all operation of handling and setting of the glass.
- Dolphin Alavo mirrors have a plastic safety film applied to the painted side of the mirror; the film has a triple function:
 1. If the glass breaks, the splinters stick to the film, thereby preventing injuries and damage.
 2. It protects the paint from scratching
 3. It protects the paint from damp environments

The safety backing films comply with European EN 12600 safety standards.

ALAVO MIRRORS

CLEANING AND MAINTENANCE

Glass can get dirty, especially during the construction of a building! But care must be taken when cleaning – it scratches easier than some might think.

Corrosive contamination must be avoided at all times, especially from plaster, mortar, concrete and cement slurry, all of which are alkaline and therefore capable of corroding the glass surface. Any such impurities must be washed off the glass immediately. Rinse with plenty of clean water to avoid scratching the surface. Use a soft clean sponge, cloth or chamois. Do not try to remove impurities while the glass is dry. Never use sharp objects, such as scrapers, to clean the glass.

To protect the glass during construction, Dolphin recommend covering installed glass with sheets of plastic film.

The other teams working on the project should also be informed about handling the glass properly.

When cleaning the mirror, the edges must always be dried quickly and thoroughly.

Dolphin Alavo mirrors can be cleaned with clean water only

IMPORTANT

Never use ammonia-based products or abrasive products (such as anti-limescale products) to clean Dolphin Alavo mirrors.

The Dolphin Alavo mirrors are new generation Ecological mirrors which stand out for:

- Copper free metal coating
- Low level lead paints
- Resistance to corrosion

ALAVO GAS STRUTS

REMOVE AND REFIT A GAS STRUT



1. Open and securely prop the flap

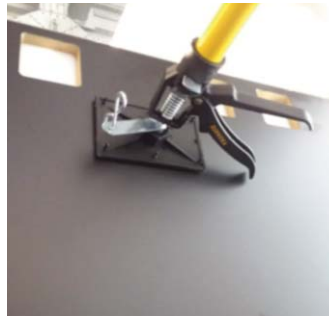

Use a **strong and secure** prop

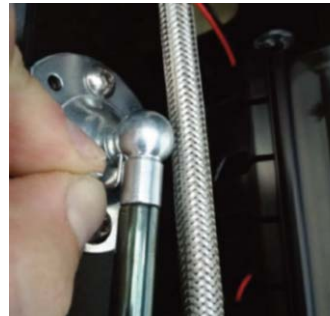

2. Remove one locking pin



Locking pin removed

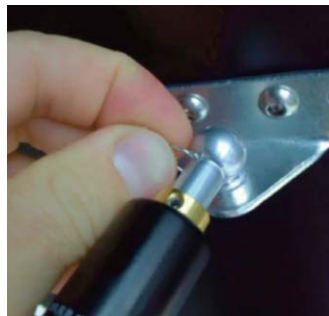

3. Remove the other locking pin

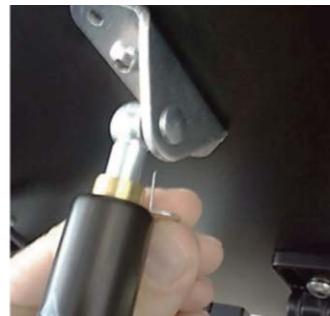

Locking pin removed



4. Pop top of strut off the bracket



Support the strut and lower it



5. Pop bottom of strut off the bracket

To refit a strut follow steps 1 to 5 above in reverse order ensuring the ball sockets are thread tight onto the strut first **NOTE:** A gas strut **must only** be used with the thin end at the bottom and the fat end (the cylinder) at the top

ALAVO GAS STRUT ADJUSTMENT

ADJUST PRESSURE IN GAS STRUT

To adjust gas pressure, slacken grub screw in short bursts, and maintain equal pressure between strut pairs.



NOTE Test mirror weight repeatedly to ensure sufficient gas remains.
Do not over-tighten grub screw.

RELEASE GRUB SCREW IN SHORT BURSTS AND WITH CAUTION

COMMISSIONING CHECKLIST

Tools & Materials

- Pipe cutters
- Range of screwdrivers
- 2mm hex key
- 2.5mm hex key
- 5mm hex key
- T20 pin torx key
- Adjustable spanner
- Water pump pliers
- Rags
- Camera
- Foaming soap (not standard liquid soap)

Initial checks

- Mirrors aligned with 3mm gap between each
- Mirrors latch securely when in closed position
- Open left mirror first
- Open each mirror in sequence carefully ensuring no conflict with other mirrors
- If conflict between mirrors, check O&M manual for instructions
- All plumbing connections tight
- Soap tubing straight and level across entire unit from tank to vent without undulations

Function checks

- Ensure basin area completely clear
- Turn on power and water
- Close mirror flaps
- Ensure all taps discharge once simultaneously
- Wait 30 seconds before activating the unit
- All strip lights and mirror back lights on
- All taps discharging water when activated
- Angle of tap flow correct – see O&M manual
- All hand dryers activating
- Adjust all lighting to colour required
- Adjust light sensor – see O&M manual
- Soap/paper refill light working
- Pour foaming soap liquid into the tank (thin watery consistency)
- All soap dispensers discharging foam soap when activated

Final checks

- Take exterior and interior photos of all units and email to info@dolphinsolutions.co.uk
- Cleaners/facilities staff advised to use foaming soap ONLY
- Cleaners/facilities staff shown how to put unit into cleaning mode with keyswitch
- Appliance Switch
 - Operation Mode vs Service Mode
 - Cleaning
- All baseplates within units dry (if they are wet with either water or soap a leak is likely) recheck all pipework and connectors

FOR OFFICE USE ONLY

Project name and location _____

Project reference number _____

Commission complete by _____

Date _____

Further actions (leave blank if none) _____



Dolphin Solutions Ltd
Southpoint, Compass Park,
Junction Road
Bodiam, TN32 5BS,
United Kingdom
T +44 (0)1424 202 224
info@dolphinsolutions.co.uk
dolphinsolutions.co.uk

© Dolphin Solutions Ltd