

BCL632F

# DOLPHIN PANEL MOUNTED FOAM SOAP DISPENSER

---

INSTALLATION AND MAINTENANCE GUIDE



November 2019

# INDEX

3	Technical Data
4	Pre-Installation Information
5	Pack Contents
6-8	Installation
9	Filling The Soap Tank
10	Settings Adjustment
11	Spare Parts List
12	Maintenance
13	Warranty
14-15	Troubleshooting

# TECHNICAL DATA

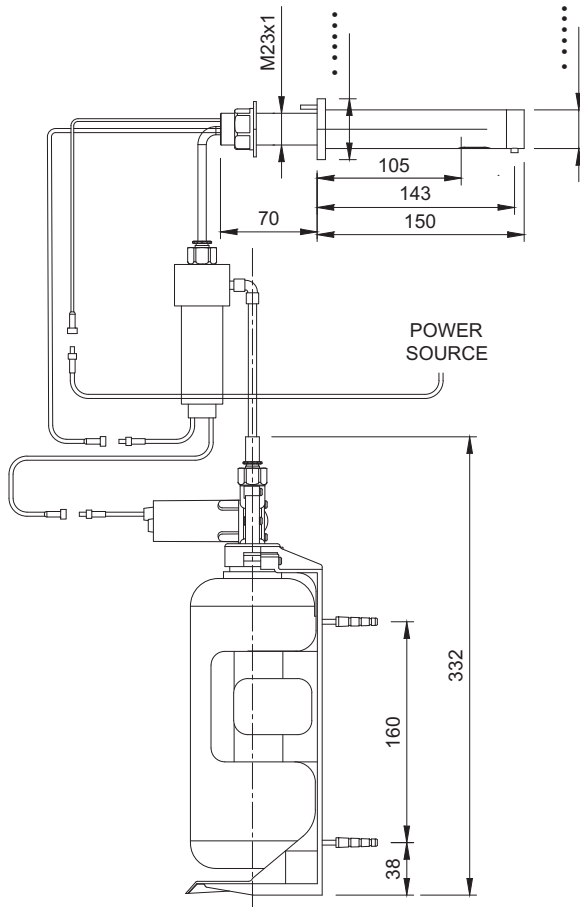

Capacity	1 Litre / 33.8 oz.
Power Supply	12V transformer
Soap viscosity	1-4 Cps
Standard discharge	Varies according to viscosity and soap consistency
Sensor range	30-100 mm +/- 10 mm (Adjustable by remote control)
Soap PH 5.5-8.5	Soap Type clear foaming liquid, no abrasives

# PRE INSTALLATION INFORMATION

## CHECK CONTENTS

After opening the package, check each part with the "Pack Contents" section. Make sure all parts are accounted for before discarding any packaging material. If any parts are missing, do not attempt to install the touch free foam soap dispenser until you obtain the missing parts.

## WARNINGS

- › Highly reflective surfaces directly beneath the sensor of this product, in particular polished finish basin wastes/ strainers, will cause false activation of the infrared sensors and can result in malfunction. We recommend satin or matt finish products which can be found on our website.
- › It is very important to allow permanent access to the mounting tail/nut of this product for future servicing and repair. Where this is not possible see our wall plate mounted products.
- › Do not install the system facing a mirror or any electronic system operated by an infrared sensor.
- › To prevent reflection problems, it is recommended to keep a minimum distance of 300 mm between the soap dispenser and any other objects.

## IMPORTANT:

Keep in mind that when using the tap installed next to the soap dispenser, the user hands should not interfere with the soap dispenser sensor detection area.

Correct Installation



Incorrect Installation

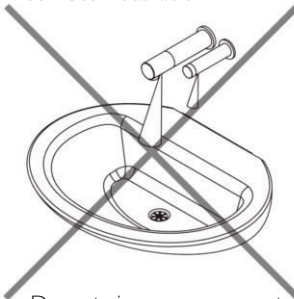

Do not aim soap sensor at water stream

# PACK CONTENTS

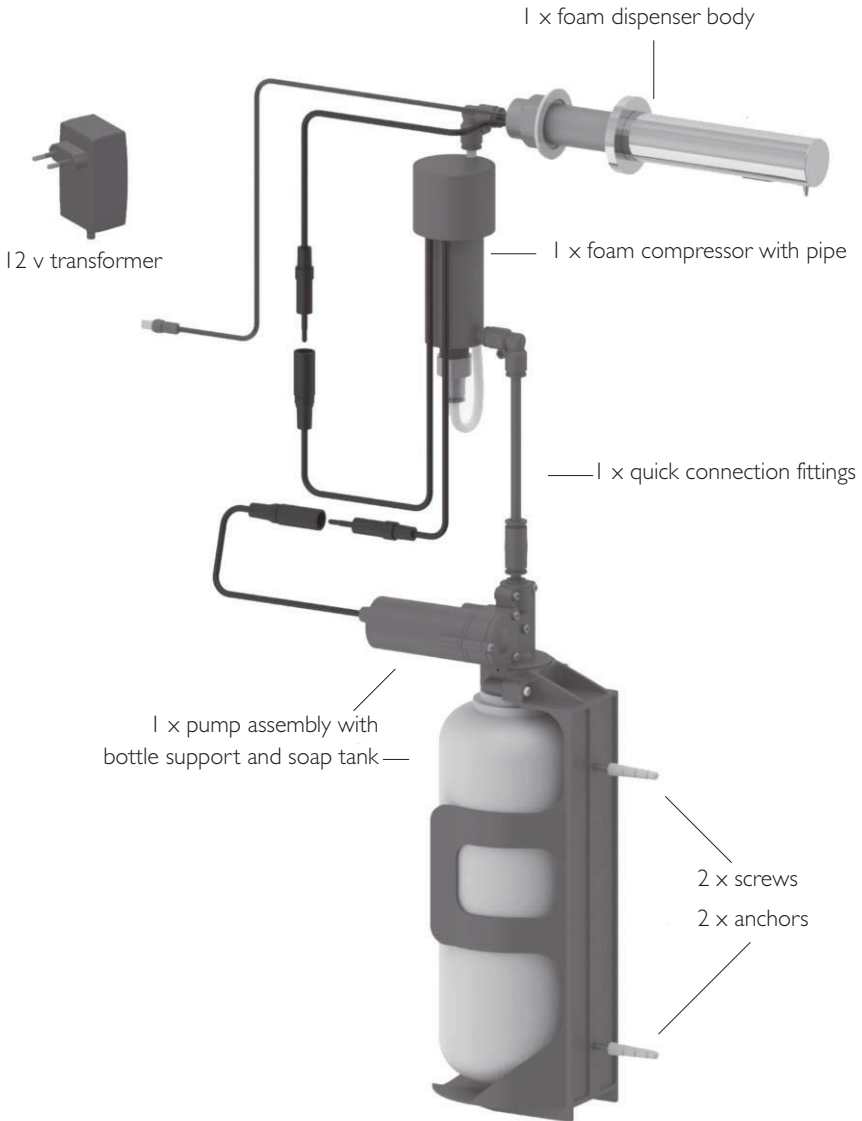

# INSTALLATION

## STEP 1 REMOVE ALL MOUNTING HARDWARE

- › Drill a hole (23-24 mm) at the designated installation location of the foam soap dispenser body.
- › Drill a small hole (2-3 mm) above the previous one for the anti-rotation pin. Consult the diagram.
- › Remove the hexagonal nut and the disk from the base of the soap dispenser spout.

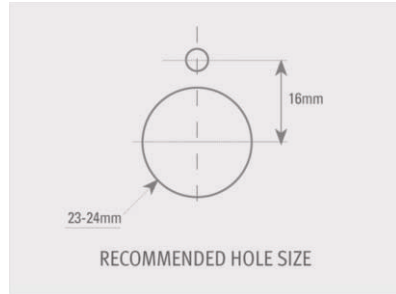

## STEP 2 – INSTALLING THE SOAP DISPENSER

1. Insert the Soap dispenser base and the anti-rotation pin into the drilled holes. Fix the base behind the wall with the hexagonal nut and the disk.
2. Fix the bottle support to the desired location. The pump MUST be within reach range of the Com cable and black supply tube.

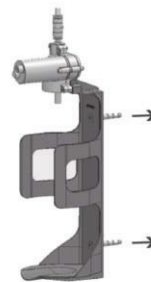
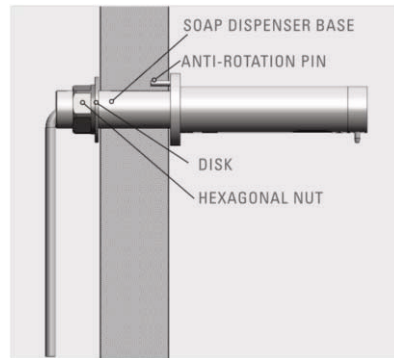

# INSTALLATION

3. Connect the tube extending out of the soap dispenser body to the quick connection fitting at the top of the foam compressor by snapping it in.

Make sure it is firmly plugged in.

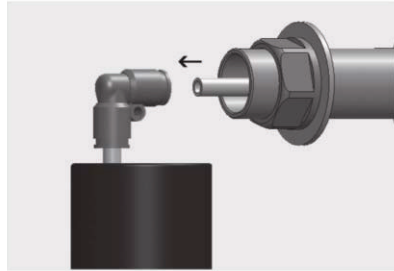

4. Connect the quick connection fitting to the soap dispenser pump.

Make sure it is firmly plugged in.

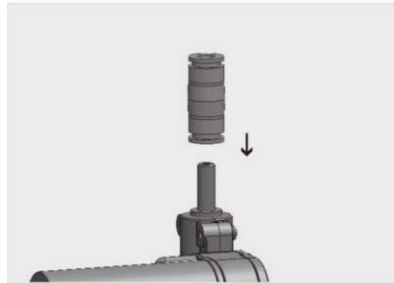

5. Connect the tube extending from the foam compressor to the top of the soap dispenser pump by snapping it into the quick connection.



**IMPORTANT:** Make sure to cut the tube to the minimum required length

# INSTALLATION

## STEP 3. CONNECTING THE POWER SOURCE

1. Remove the protective sticker covering the sensor:

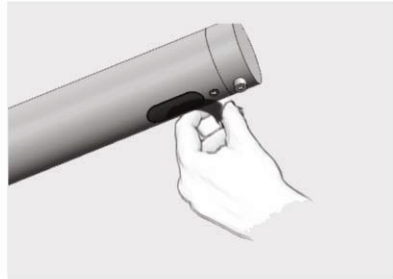

2. Connect the matching connector from the foam dispenser body to the compressor unit, and the compressor unit to the pump connector. Please note that since the connector is water proof, some pressure must be applied for a perfect seal.



**IMPORTANT:** the 4 contacts connector should be connected properly so that the white o-ring is not visible and a clicking sound is heard.

**PAY ATTENTION:** If the 4 contacts connectors are not connected properly, the soap dispenser pump will not operate properly.

3. Plug the transformer into the electricity socket and connect the transformer connector



4. Wait about 10 seconds before placing your hands in the sensor range to avoid adjustment mode.





## FILLING THE SOAP TANK

1. Unscrew the soap tank from the pump assembly and pull it out from the bottle support.



2. Fill the bottle with foam soap up to the top line.  
Make sure the bottle is clean before filling it with soap.



3. Insert the bottle back into the bottle support.



4. Screw the soap tank back into the pump assembly.  
Make sure the tank is firmly secured into place.



5. Press and hold the refill button located at the back of the pump assembly until soap is dispensed from the soap dispenser spout. Alternately, use the FILL function on the remote control (if available), see page 10.

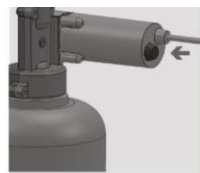

**Note:** When the soap in the soap tank reaches the bottom line, the tank needs to be refilled.  
To refill the soap tank please refer to steps 1-5.



# CARTRIDGE REFILLING INSTRUCTIONS

**01**

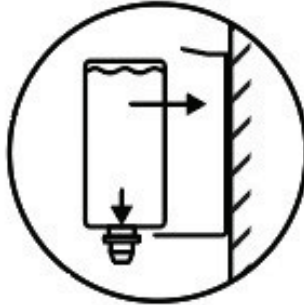

**PULL OUT SPOUT  
REMOVE FOIL SEAL  
SLIDE INTO BRACKET**

**02**

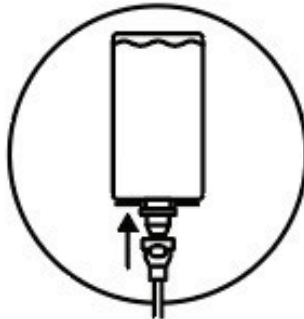

**PUSH CONNECTOR  
FIRMLY ONTO  
REFILL SPOUT**

**03**



**CLICK INDICATES  
SUCCESSFUL  
CONNECTION**

## REMOTE CONTROL FUNCTIONS

If available, the foam dispenser remote control can adjust the dispenser's settings. To use the remote control hold it in front of the sensor at a distance of 10-15cm.

**Attention:** The remote control will not operate out of the recommended range (too close or too far).

The remote control can be used to adjust the following functions:

- 1 SOAP QUANTITY** Press the + sign on the SOAP button to increase the soap quantity by increasing the dispensing time. Press the - button to decrease it.  
**Indication:** continuous blinking blue light in the sensor eye.
- 2 AIR QUANTITY** To improve soap consistency ("foamability") change the amount air to be mixed. Press the + sign on the AIR button to increase the air quantity and the - to decrease it. **Indication:** 2 blinks of the blue light in the sensor eye.
- 3 RES** This function resets the sensor back to its factory settings.
- 4 TEMPORARY OFF FUNCTION** This function temporarily disables the dispenser. Use this function to perform maintenance in front of the sensor without activating the system (for example: cleaning) The soap dispenser will shut off for one minute after this button is pressed once. To return to normal operation before the minute is over, press the On/Off button again.
- 5 FILL THE SOAP TANK** Once the soap tank has been filled \refilled, press the FILL button. The pump will run for one minute, priming the piping with soap. Once soap begins dispensing from the spout, priming is complete. Press the FILL button again to stop the priming before the minute is over. **Indication:** continuous solid blue light in the sensor eye.

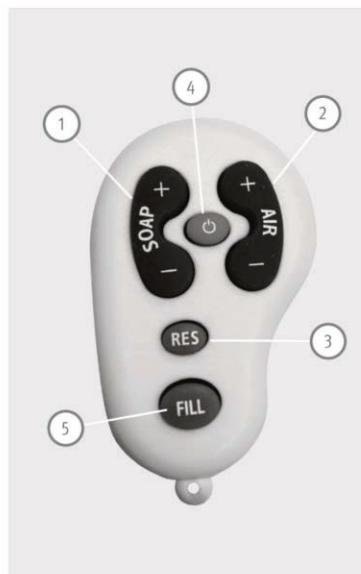

## SPARE PARTS LIST

Seals & Screws Kit .....	BC07210098
10-Pack Sensor Kit .....	BC07220338
Soap Dispenser Pump .....	BC07222013
Pump+Compressor Kit .....	BC07222026
Soap Bottle 1L .....	BC07100020
Soap Bottle 1L Support Kit .....	BC07220087
10-Pack Foam Filter .....	BC07212015
12v Transformer (EU) .....	BC06522081
12v Transformer (UK) .....	BC06522086
12v Transformer (US) .....	BC06522080
12v Transformer (AU) .....	BC06522085
Remote Control for Foam Dispenser .....	BC07100009

# MAINTENANCE

## **CARE AND CLEANING OF CHROME AND SPECIAL FINISHES**

**DO NOT** use steel wool or cleansing agents containing alcohol, acid, abrasives, or their like. Use of any prohibited cleaning or maintenance products or substances could damage the surface of the soap dispenser. For surface cleaning use **ONLY** soap and

water, then wipe dry with a clean cloth or towel. When cleaning bathroom tiles, the soap dispenser should be protected from any splattering of harsh cleansers.

## **DISASSEMBLE OF THE SOAP PIPE FROM THE PUMP**

The soap pipe can be disconnected from the soap pump by a simple slide and pull action. The sliding ring of the quick connection fixation nipple on the pump should be pulled down. It releases the open end of the soap pipe which can then be easily pulled out.

## **FILTER CLEANING INSTRUCTIONS (FOAM DISPENSER ONLY)**

- › This soap dispenser is provided with a foam filter. It is recommended to clean the filter every six (6) months.
- › If the soap supply has decreased, this may be caused by the clogged filter. The filter can be cleaned as follows:
  1. Use a wrench to unscrew the quick connection fitting from the foam compressor and pull out the filter housing.
  2. Remove the filter from the housing.
  3. Replace the filter (recommended) or wash it under running water for a temporary fix.
  4. Reassemble the parts.

## LIMITED WARRANTY

Dolphin Solutions Ltd warrants that its electronic products will be free of defects in material and workmanship during normal use for two years from the date the product is purchased.

If a defect is found in normal use, Dolphin Solutions Ltd will, at its discretion, repair, provide a replacement part or product, or make appropriate adjustments. Damage caused by accident, misuse, or abuse is not covered by this warranty. Improper care and cleaning will void the warranty. Proof of purchase (original sales receipt) must be provided to Dolphin Solutions Ltd with all warranty claims.

Dolphin Solutions Ltd is not responsible for labor charges, installation, or other incidental or consequential costs other than those noted above. In no event shall the liability of Dolphin Solutions Ltd exceed the purchase price of the product.

If you believe that you have a warranty claim, contact your Dolphin Distributor, Dealer or Plumbing Contractor. Please be sure to provide all pertinent information regarding your claim, including a complete description of the problem, the product, model number, the date the product was purchased, from whom the product was purchased and the installation date. Also include your original invoice.

DOLPHIN AND/OR SELLER DISCLAIM ANY LIABILITY FOR SPECIAL, INCIDENTAL OR CONSEQUENTIAL DAMAGES. This warranty excludes product damage due to installation error, incorrect maintenance, wear and tear, battery, product abuse, or product misuse, whether performed by a contractor, service company, or the consumer. This warranty does not cover product damage caused by the following:

- Incorrect installation.
- Improper manipulation, tampering, bad or lapsed maintenance.
- Use of the soap outside of viscosity specifications.
- Alteration of the original soap/foam dispenser components (including pipes).

# TROUBLE SHOOTING

PROBLEM	INDICATOR	CAUSE	SOLUTION
Foam is not dispensing from spout	Blue light in the sensor flashes (once) and the soap pump operates.	Soap has run low or is completely out.	Refill the soap tank. <i>Refer to page 7</i>
		The soap tank has been filled, but soap has not reached the spout.	Press the refill button located at the bottom of the pump to prime the soap until it is dispensed from the spout.
		The connectors between the pump and the electronic unit are not connected properly.	Connect the connectors properly so that the white o-ring is not visible.
		The pipe for the specific dispenser is bent or curved and does not reach the bottom of the soap tank.	Make sure the pipe is adjusted inside the tank for an ideal soap intake.
		Filter is clogged.	Clean or replace the filter. <i>Refer to page 10</i>
Foam is not dispensing from spout	Blue light in the sensor does not flash (once) when the users' hands are within the sensor range.	Sensor is picking up reflections from the washbasin or another object.	Eliminate the cause of reflection.
		Connectors between the electronic unit and power source are disconnected or not properly connected.	Properly connect the electronic unit connectors to the power source connector.

# TROUBLE SHOOTING

PROBLEM	INDICATOR	CAUSE	SOLUTION
Foam does not stop dispensing		The connectors between the pump and the electronic unit are not connected properly.	Connect the connectors properly so that the white o-ring is not visible.
Foam is too diluted		Air ratio is too low.	Increase air ratio using the remote control. <i>Refer to page 8</i>
Foam is too dense		Air ratio is too high.	Decrease air ratio using the remote control. <i>Refer to page 8</i>
Soap dispenser pump does not work	Blue light flashes (once) and the foam compressor operates.	The connectors between the soap pump and the compressor are not connected properly.	Connect the connectors properly so that the white o-ring is not visible.
Foam compressor does not work	Blue light flashes (once) and the motor operates.	The connectors between the compressor and the electronic unit are not connected properly.	Connect the connectors properly so that the white o-ring is not visible.



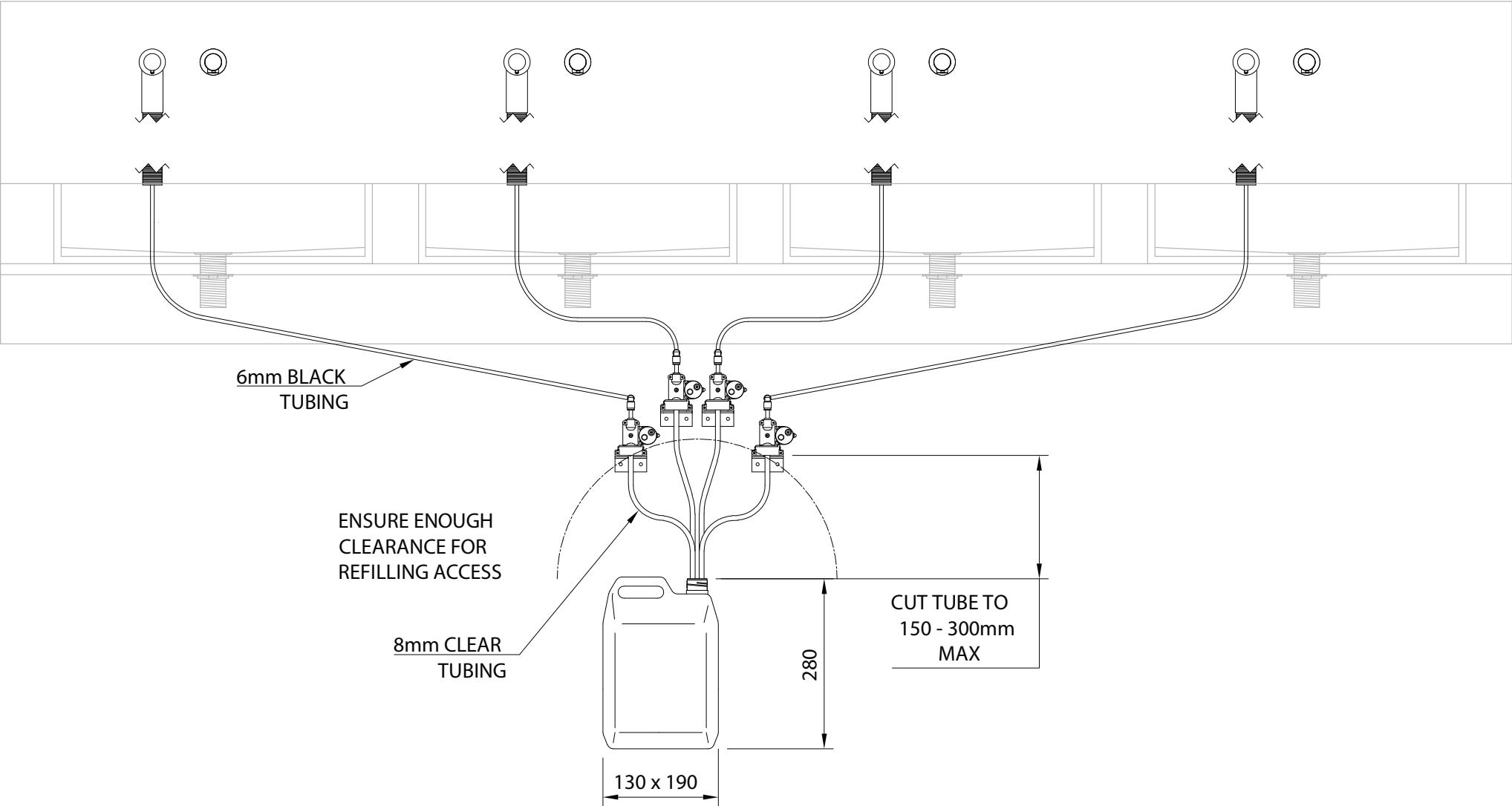



**Dolphin Solutions Ltd**

Southpoint, Compass Park, Bodiam,  
Robertsbridge, TN32 5BS

Tel: +44 (0)1424 20 22 24

Fax: +44 (0)1424 205 200

[info@dolphinsolutions.co.uk](mailto:info@dolphinsolutions.co.uk)

[www.dolphinsolutions.co.uk](http://www.dolphinsolutions.co.uk)